

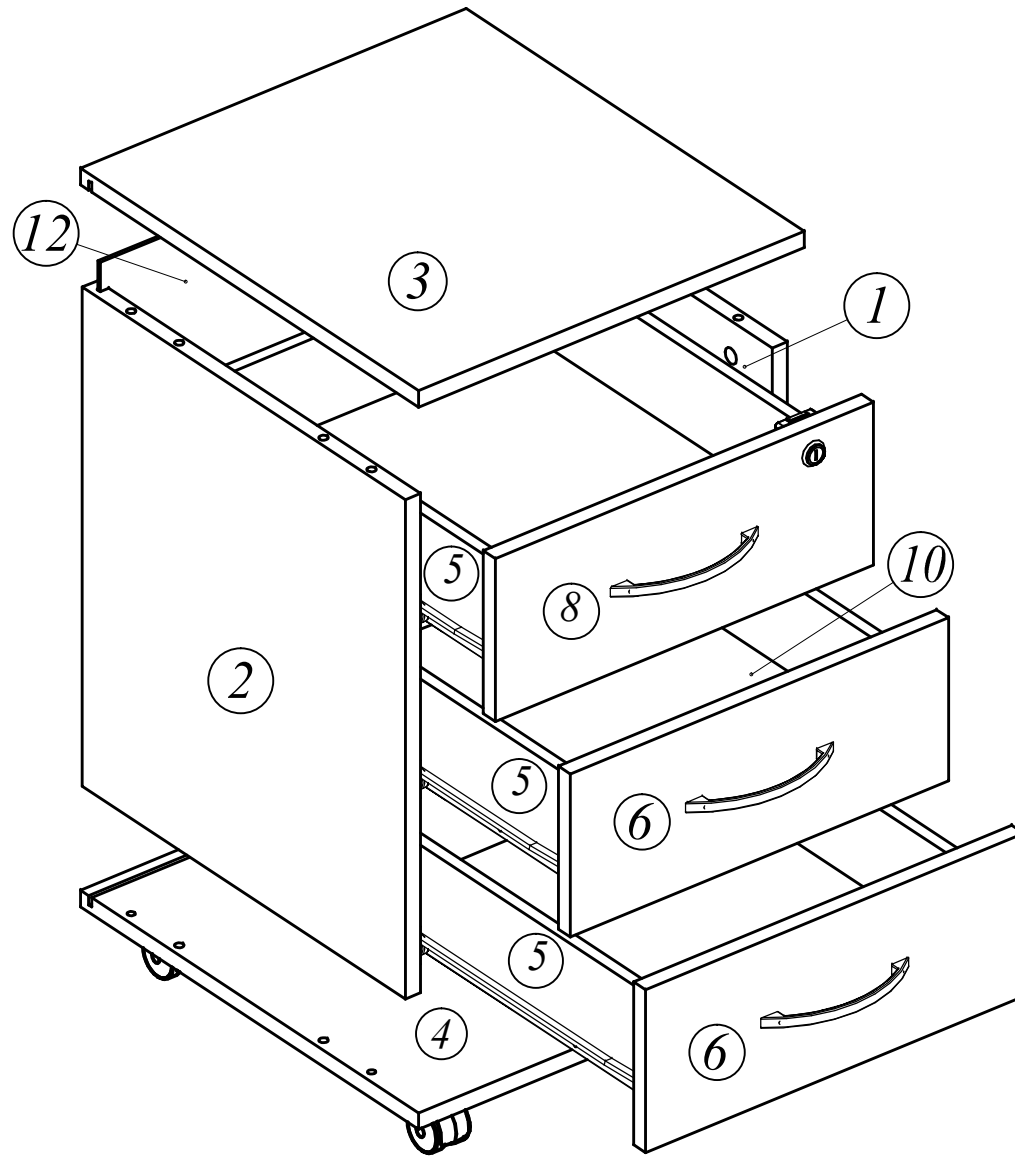

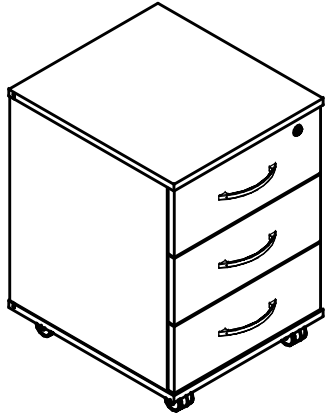

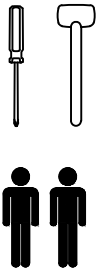

TM-3 (TM-3)

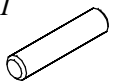
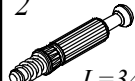

412x450x551

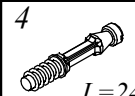

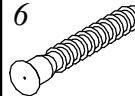
ERC

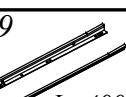
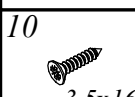
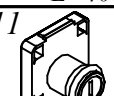
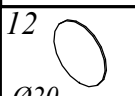
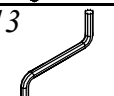
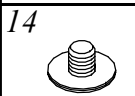
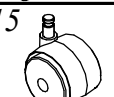
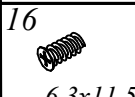
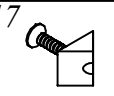
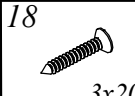
1		x8	2		x4
				<i>L=34</i>	
3		x4	4		x6
	$\varnothing 15$			<i>L=24</i>	
5		x6	6		x4
	$\varnothing 12$				
7		x6	8		x3
9		x3	10		x24
	<i>L=400</i>			$3,5 \times 16$	
11		x1	12		x6
				$\varnothing 20$	
13		x1	14		x4
15		x4	16		x12
				$6,3 \times 11,5$	
17		x4	18		x4
				3×20	

TM-3 (TM-3)

2

